

a) Verlängerung durch Unterscheidung zwischen Befehls- und Datenzugriffen

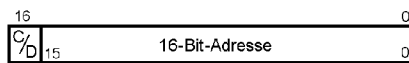

b) Weitere Verlängerung durch Unterscheidung zwischen Anwender- und Systemzustand

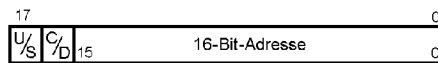

c) Verlängerung durch Bankregister

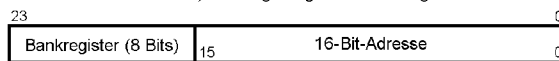

d) Verlängerung eines Abschnitts aus dem Adreßraum durch Bankregister

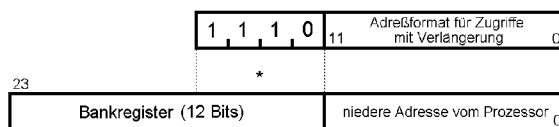

\*: Dieser Abschnitt der Prozessor-Adresse wird beim Zugriff aus dem Bankregister ersetzt

e) Mehrere Bankregister für verschiedene Zugriffe

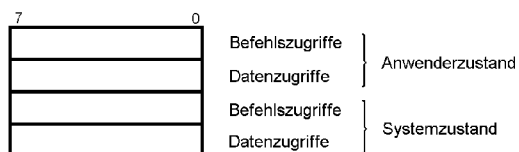

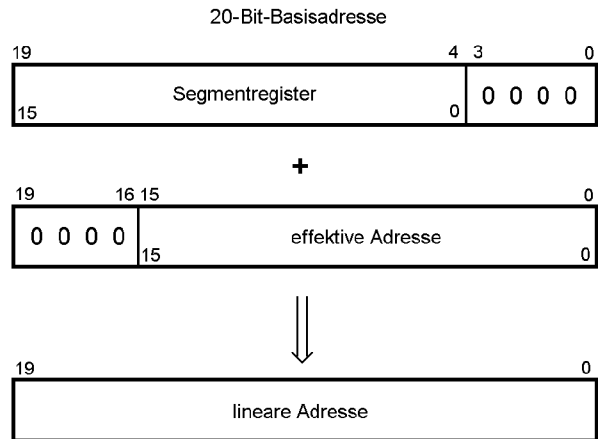
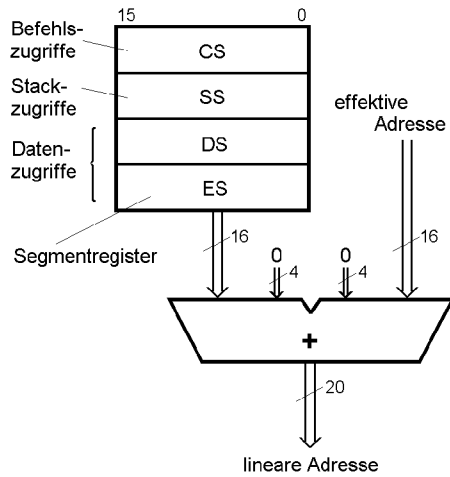

a) vollständige

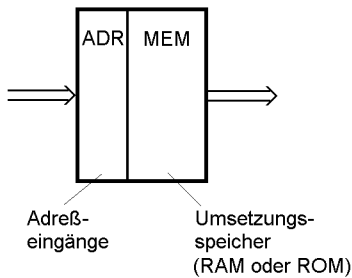

b) teilweise Umsetzung

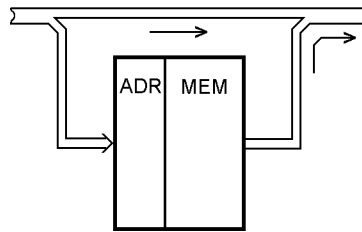

Beispiel: ankommende Adresse

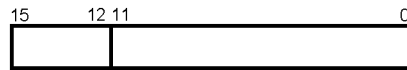

abgehende Adresse:

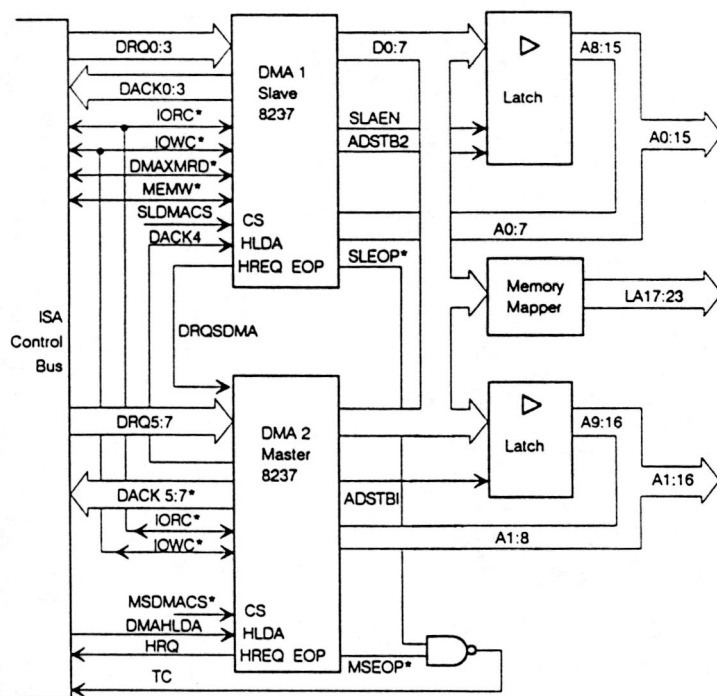
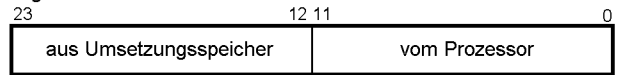

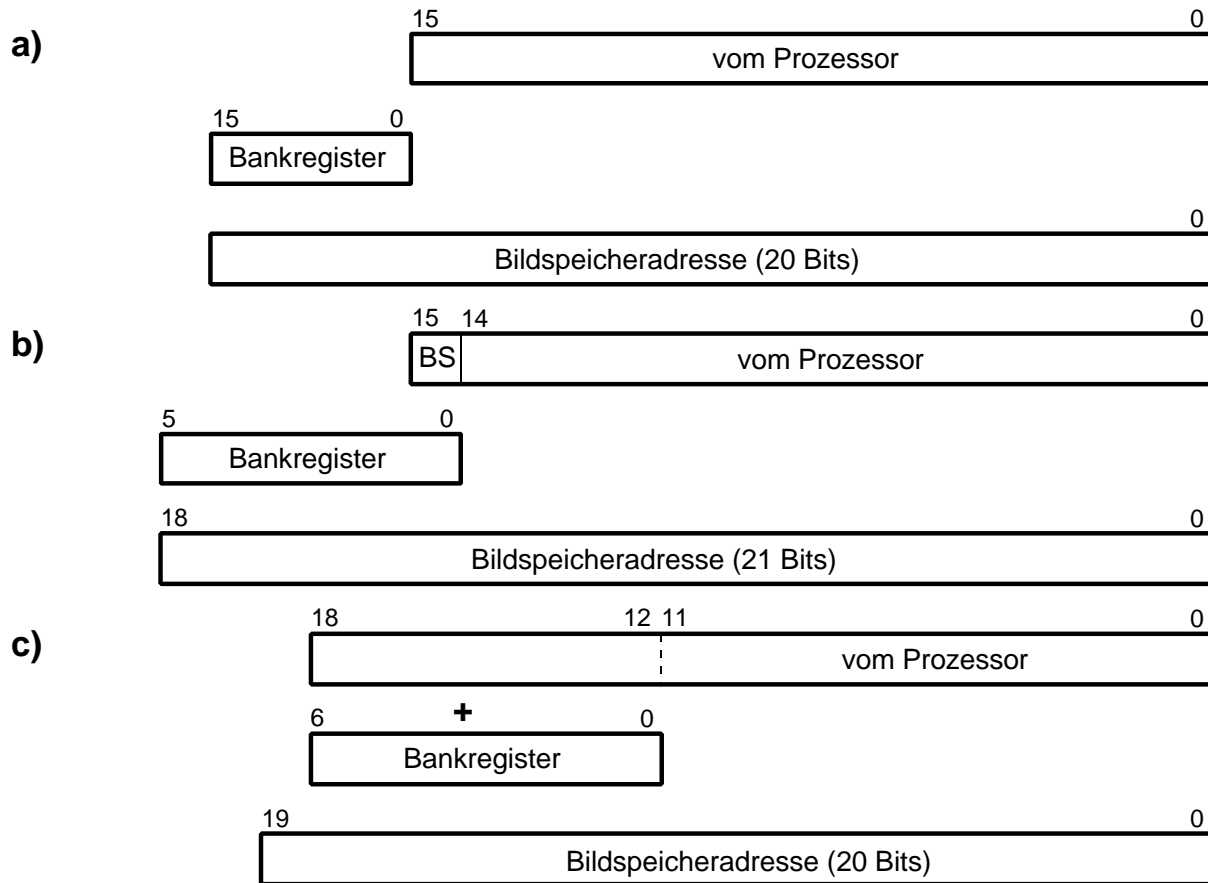

Speicheraufteilung:

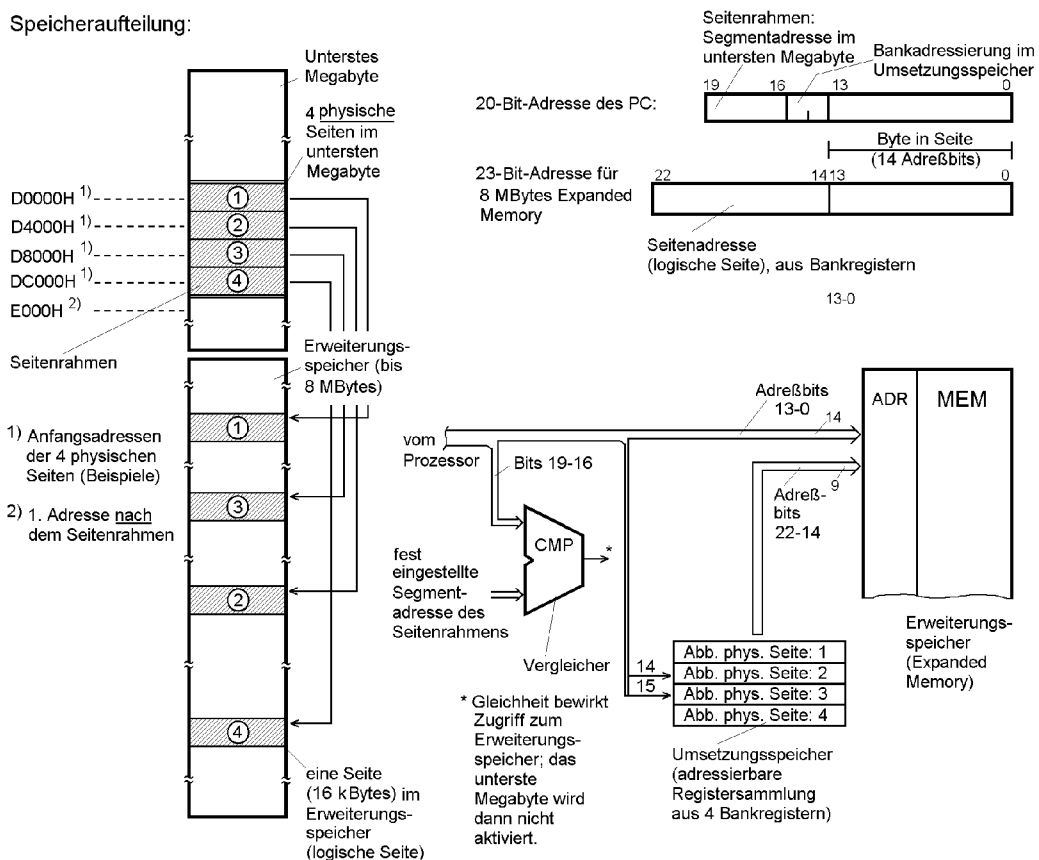

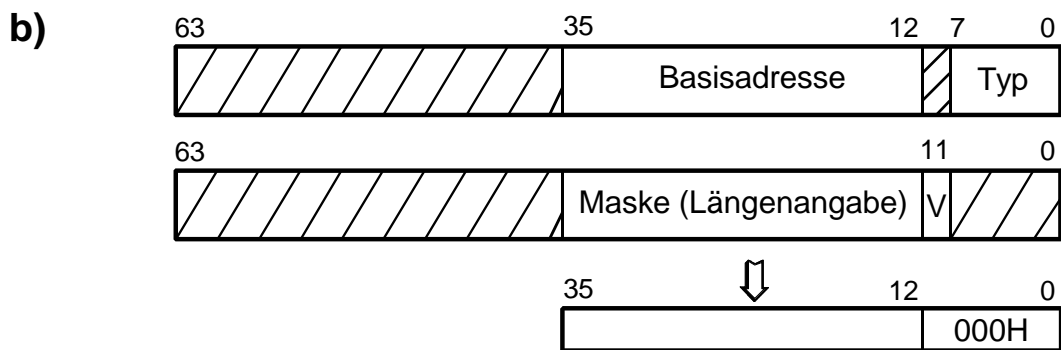
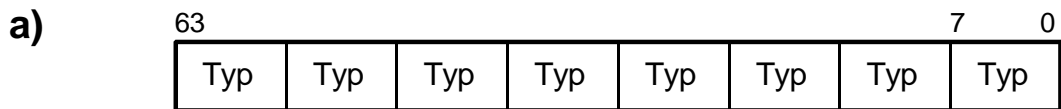
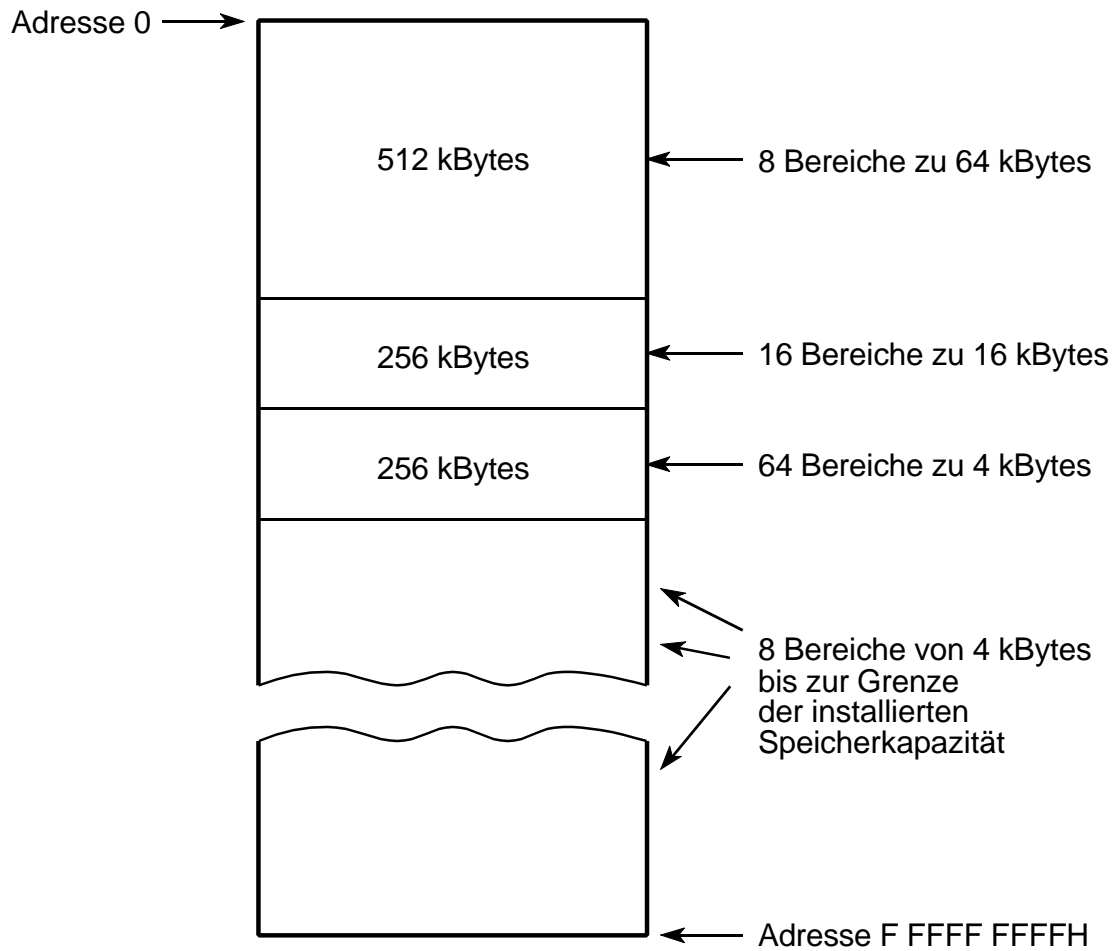

: reserviert

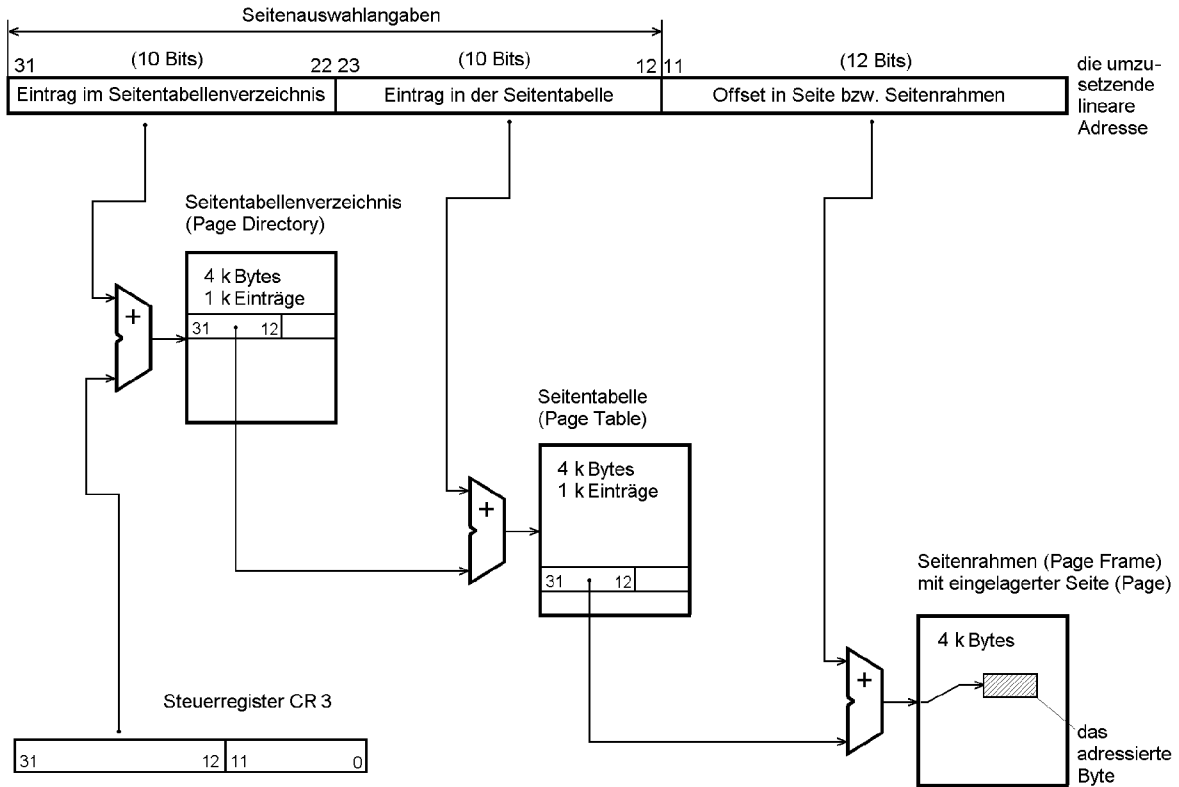

Diese (sehr teure) Anordnung . . .

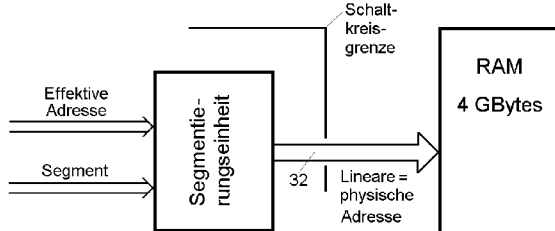

Kleiner RAM,  
beispielsweise  
4 MBytes

0	1	2	3
4	5	6	7

Seitenrahmen zu 4 kBytes  
(insgesamt 1024)

. . . wird ersetzt (nachgebildet) durch einen  
seitenorientierten virtuellen Speicher.

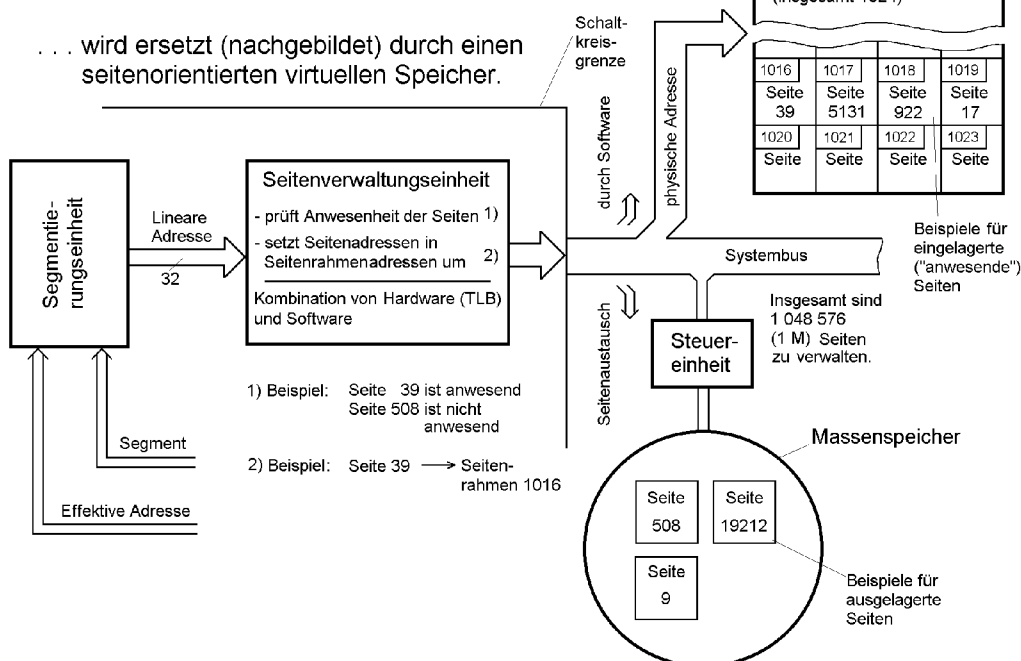

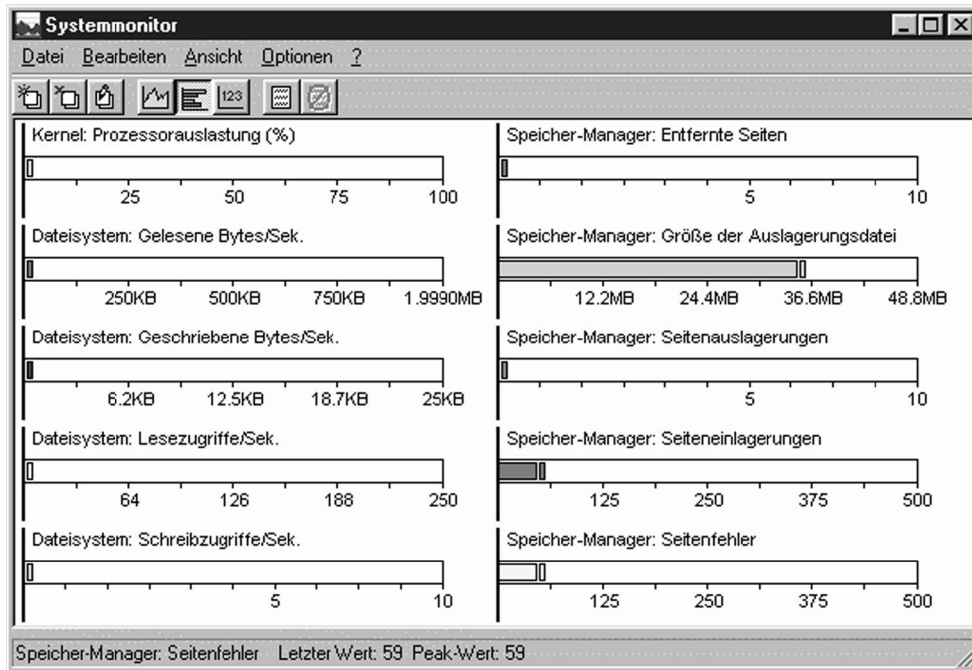

**Virtueller Arbeitsspeicher**

! Diese Einstellungen, die die Systemleistung negativ beeinflussen können, sollten nur von erfahrenen Benutzern und Systemadministratoren geändert werden.

Virtueller Arbeitsspeicher

Windows verwaltet die Einstellungen für den virtuellen Speicher (empfohlen)

Es gelten benutzerdefinierte Einstellungen für den virtuellen Speicher

Festplatte: C:\ 6782 MB frei

Minimum: 0

Maximum: Kein Maximum

Virtuellen Speicher deaktivieren (nicht empfohlen)

OK Abbrechen

Detailed description: This is the 'Virtual Memory' settings dialog box. It has a warning icon and text stating that these settings can negatively affect system performance and should only be changed by experienced users or administrators. The 'Virtual Memory' section has two radio buttons: 'Windows manages the settings for virtual memory (recommended)' (which is selected) and 'Use user-defined settings for virtual memory'. Below these are three settings: 'Hard disk' (a dropdown menu showing 'C:\ 6782 MB frei'), 'Minimum' (a spin box set to '0'), and 'Maximum' (a dropdown menu set to 'Kein Maximum'). There is also an unchecked checkbox for 'Deactivate virtual memory (not recommended)'. At the bottom are 'OK' and 'Abbrechen' buttons.

